

MASON CONTRACT

Makes Motorization as Simple as...



ONETM

two, three

MASON CONTRACT PRODUCTS

Manufacturer of window treatments and  **ONE**TM motorized hardware systems

MCP

Mason Contract Products' business philosophy has been designed around three important words:

Total Customer Satisfaction.

You can see it in the way we listen, exchange ideas, and develop concepts. We pay attention to every detail in the manufacturing of our window treatments. To further our philosophy of providing the best solutions for our customers, we've developed our own line of motorized systems for roman shades, draperies and roller shades.

**Our mission
is to make your
life easier.**

Mission Statement

Mason Contract Products' mission is to bring designers' and architects' concepts to reality, enhancing the aesthetic appeal of the guestroom/public area. Mason accomplishes this by manufacturing the highest quality products at the most cost-competitive price, utilizing only first-quality materials and highly trained craftsmen in the manufacturing process. In addition, all unused materials are recycled, representing Mason's commitment to preserving the environment.

Introducing 

Our new product line of environmentally conscious motorized window treatments and controls.

We only have one world. And we all need to take care of it. That's why ONE™ not only stands for the best in motorized systems, it also expresses our commitment to the environment. A commitment that runs deep within our company, and ensures that all our motorization products contribute to the energy efficiency of the buildings in which they are installed.

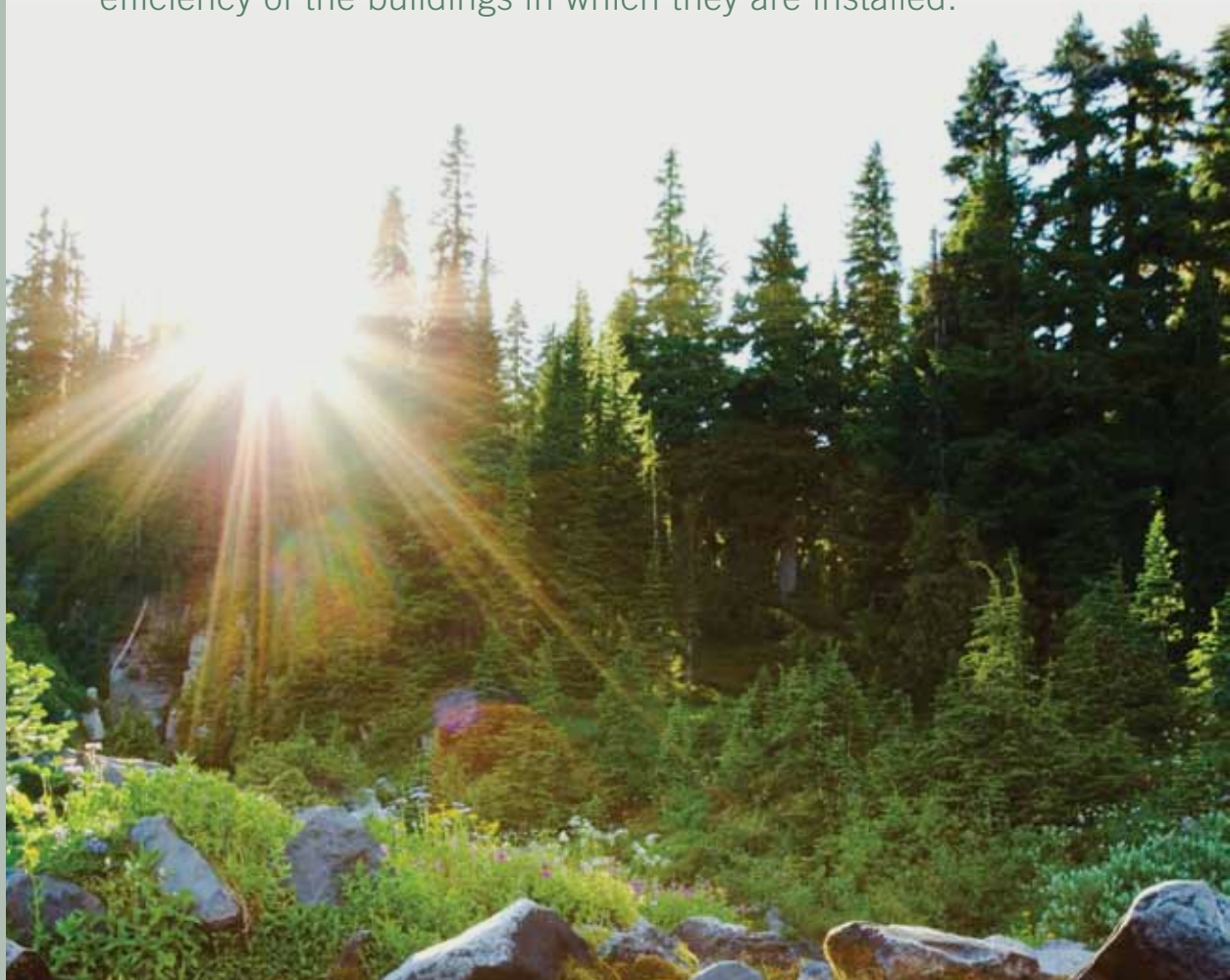

We've made our manufacturing process more efficient for you and the environment.

At Mason, we believe in working as closely with our clients as possible. That's why we now operate in both New Hyde Park, NY and Las Vegas, totaling over 150,000 sq. feet of state-of-the-art manufacturing space. At Mason, it's not only what we do, but how we do it that has made us a leading contract provider for the world's most important hotels. Nobody is more driven to satisfy the needs of the hospitality, institutional and corporate marketplace.



MOTORIZED SYSTEMS ENHANCE THE HOSPITALITY EXPERIENCE.

Motorization offers many benefits:

- Efficiently controls heat gain/heat loss thereby reducing energy costs.
- Automatically protects furnishings from harmful UV rays.
- Extends the life of window treatments by minimizing the wear and tear caused by manual operation.
- Provides ease of use for the elderly or disabled and is also an ideal solution for ADA rooms.
- Offers exceptional convenience of managing glare and creating instant privacy at the touch of a button.
- Adds a level of luxury and sophistication that distinguishes your property from the competition.
- Easily integrates with third-party systems allowing for centralized control of window treatments during check-in or check-out.

ONLY THE HIGHEST QUALITY GOES INTO  **MOTORIZED SYSTEMS.**

ONE™ motorized systems are manufactured by partnering with the best in the industry, including Somfy, the world leader in motorization and controls for window treatments.



WARRANTY

All ONE™ motorized systems carry a seven-year warranty, setting the industry standard and ensuring quality.



Elegance that works **AUTOMATICALLY.**

ONE Motorized Drapery Systems

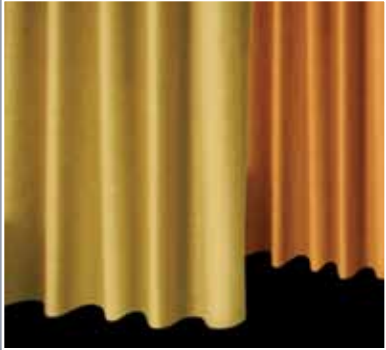

Draperies

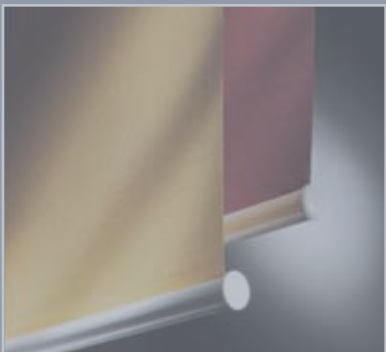
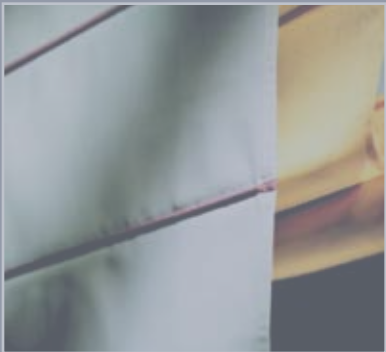

Whether your concept calls for the privacy of blackout draperies, the sophistication of decorative fabrics, or the softness of sheers, motorized drapery tracks let users create their optimum environment at the touch of a button.

Motorized Drapery Track

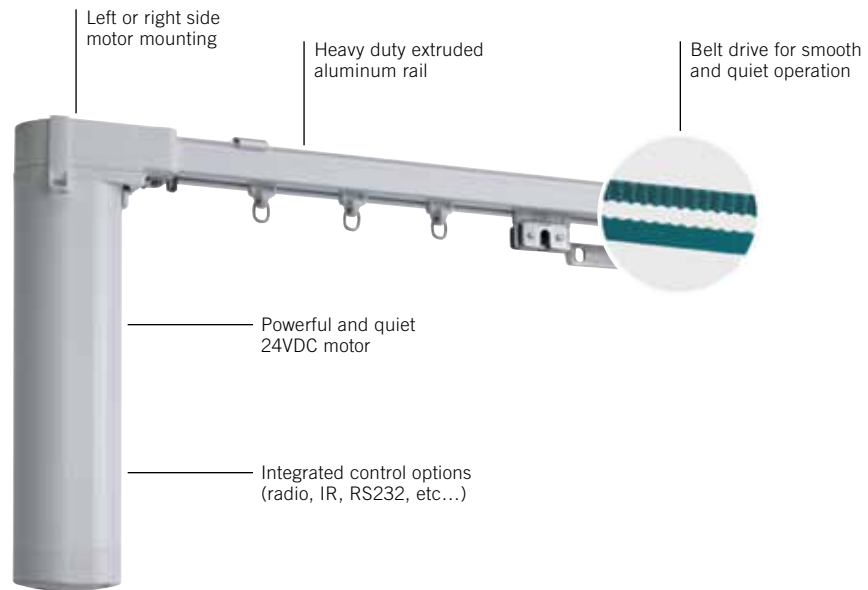

Curved track application

Custom curves and bends available to match contour of window.



Touch control and manual override

The touch control feature starts drapery in motion and prevents damage should user unknowingly attempt to operate manually. In the event of a power outage, the manual override capability permits users to operate the drapery manually.

ONE™ motorized products allow you to easily blend various end products together. Whether your project requires a dual track with light filtering and room darkening drapery panels or the combination of roller shades, draperies and roman shades, ONE™ is your solution. In addition, flexible control options allow users to operate window treatments individually or as a group in order to take control of their lighting environment and create the perfect atmosphere.

From the advantage of instant privacy to the elimination of annoying glare, ONE™ motorized products take the occupants' experience to another level of luxury.

ONE™ motorized systems work with all types of drapery textiles, so you can choose the fabric to best suit your project needs.



Enhance the energy efficiency of the ONE™ motorized system by utilizing environmentally friendly fabrics, such as the inherently fire retardant 100% post-consumer recycled polyester FRESH fabrics from Valley Forge Fabrics.



Decorative Fabric with Sheer Drapery



Decorative Fabric Drapery

Sheer Drapery



Be fashionably **IN CONTROL.**

ONE Motorized Roman Shade Systems

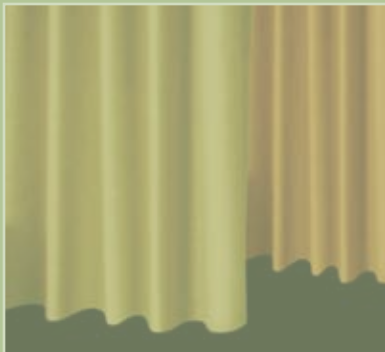

Roman shades enhance any décor, while guests can open and close them from anywhere in the room. No more struggling over hard to reach window treatments. Motorization solves the problem of adjusting large or heavy shades, and conveniently manages glare. Users also have the option of operating motorized window treatments individually or as a group.

Versatile motor systems allow you to combine various roman shade fabrics/textures with draperies and roller shades, bringing your vision to life.

Motorized Roman Shade Tube



Roman Shades

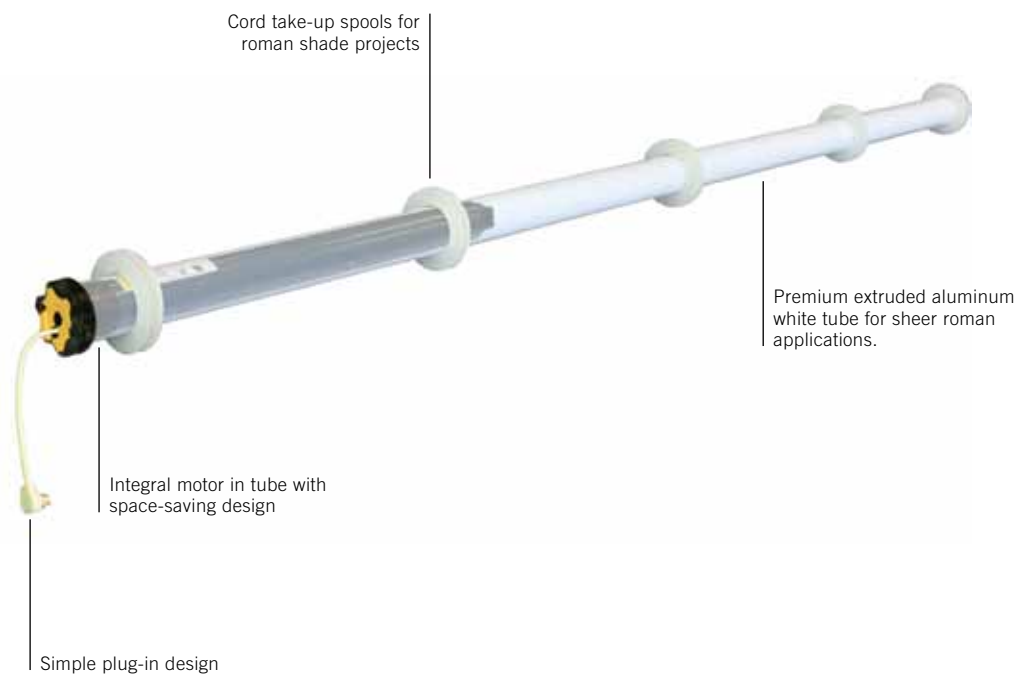



Decorative fabric roman



Solar roman

Putting roman shades in motion quietly

ONE™ motorized roman shade systems feature noise reduction technology helping to create a peaceful environment for occupants to enjoy. This is also a convenient feature for office or meeting room settings.

Sheer roman



When designing or specifying roman shades for a green project, take comfort knowing Mason's ONE™ motorized systems work well with a variety of fabrics including those that are made from recycled materials.

Performance WITH STYLE.

ONE Motorized Roller Shade Systems

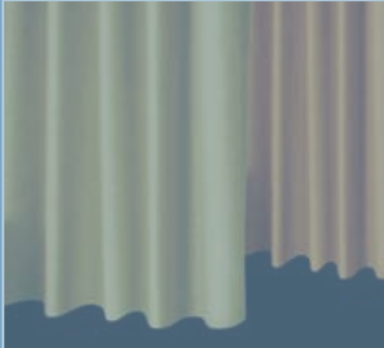

Motorized roller and solar shades represent a practical approach to decreasing energy consumption, protecting furniture from harmful UV rays, and reducing annoying glare while reading or watching television.

Depending on your project needs, options include blackout and light filtering fabrics as well as transparent shades which block light while preserving the outside view. Additionally, motorized roller shade systems may be easily combined with other types of treatments such as roman shades or draperies. And as with all ONE™ motorized systems, shades may be controlled individually or as a group.

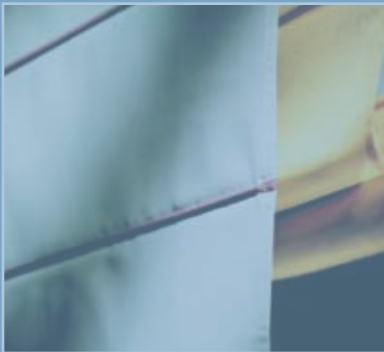

Motorized Roller Shade Tube

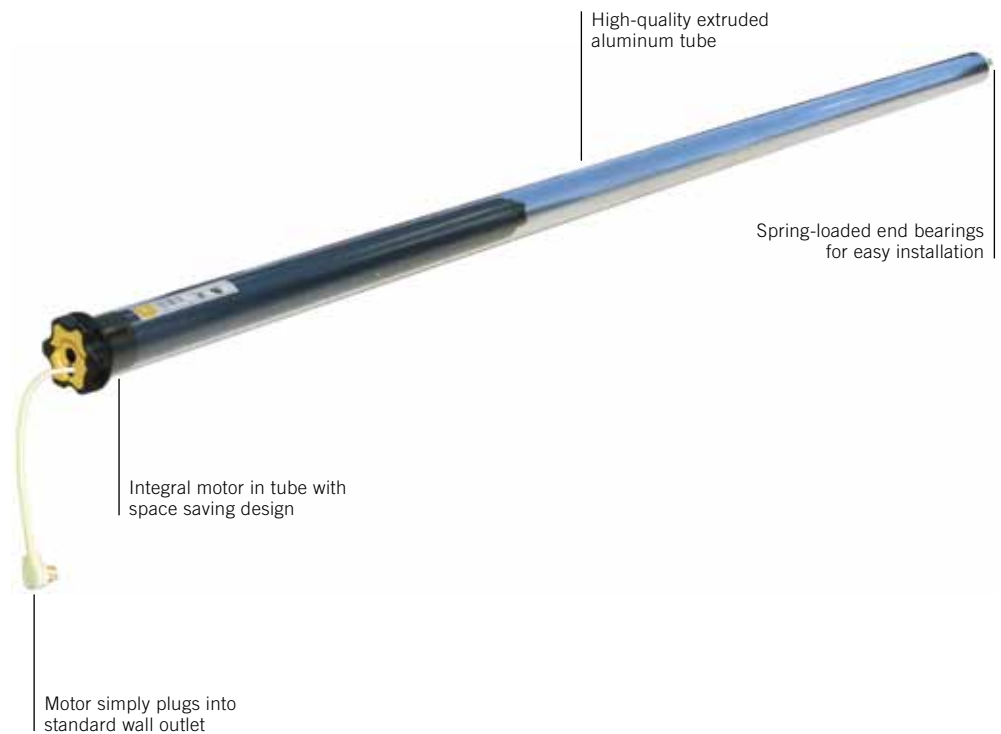

Roller Shades



Conveniently Quiet
ONE™ motorized systems put roller shades into motion with ultra-quiet precision, preserving the serenity of interior spaces.



Light Filtering Solar Roller

Blackout Roller



Select solar screen materials by Alkenz, Mermet and Phifer are GREENGUARD Certified and available for those environmentally conscious projects. Or choose from Mason's full range of performance fabrics which are offered in a variety of fresh colors to match any décor.



ONE™ offers complete control with



Choose from a broad range of colors and options—handhelds, wall switches and automatic timers. Each control features radio technology which means window coverings can be operated from virtually anywhere in the hotel room, meeting room or atrium without the need to point or aim the transmitter at the shades or blinds. Similar to how a garage door operates, radio signals travel through walls giving occupants the capability of controlling their window coverings from a variety of locations.

Remotes, wireless wall switches and timers are compatible with each other. While they operate together, they also complement each other with different functionality.

All ONE™ controls are capable of individual and group control of motorized roman shades, draperies or roller shades. Single-channel versions control one individual motorized window treatment or one group of motorized window treatments. Multi-channel versions control multiple individual motorized window treatments or multiple groups of motorized window treatments.



Standard Handheld Remote Controls

ONE™ motorized systems work seamlessly with Somfy's full line of remote controls. Handheld remotes are ideal for nightstand or coffee table areas and are offered in a variety of finishes.



Single Channel
Silver Finish



Also available in

-  *Black finish*
-  *White Finish*
-  *Water Resistant Finish
(for pool/fitness applications)*



Five Channel
White Finish

Also available in

-  *Black finish*
-  *Silver Finish*
-  *Water Resistant Finish
(for pool/fitness applications)*



Twenty Channel
Black Finish

Also available in

-  *Silver finish*



Custom Handheld
Remote Controls

Can be custom designed or labeled for a particular project.

*Available in virtually any finish,
the choice is yours.*

Standard Radio Wireless Wall Switches

Ideal for entering or exiting a room, ONE™ wireless wall switches feature the ability to customize buttons for easy identification of motorized window treatments. And, because the wall switches are wireless, installation is simple eliminating the need for an electrician. Finishes include: white, ivory and black.



*Five Channel
White Finish*



*Three Channel
Ivory Finish*



*One Channel
Black Finish*

Standard Wired Wall Switches.

Wired directly to the motor, these switches offer convenient control of motorized window treatments when entering or exiting a room. Options are available in multiple colors and include the following versions: paddle, toggle or rocker switch.



Paddle Switch



Toggle Switch



Rocker Switch



Programmable Timers

Multi-Channel Timer with on-screen display
Silver Finish

Also available in

 *Black finish*

Automation controls seamlessly INTEGRATE HOTEL SERVICES.

ONE TECHNOLOGY CREATES THE ABILITY FOR HOTEL FRONT DESKS AND RECEPTION AREAS TO CENTRALLY CONTROL MOTORIZED WINDOW TREATMENTS.

For example, once guests check in, the front desk attendant may access motorized window treatments in the hotel room via a graphical user interface (GUI) on a PC. This allows attendants to provide an ideal environment for guests by either opening or closing window treatments to highlight the view or create privacy upon arrival.



ONE™ motorized products can also interface with third-party control systems such as Crestron®, AMX®, Vantage, Control4® and others. With these systems it's possible to create timed functions allowing properties to determine when window treatments should be opened or closed in common areas or restaurants. This feature could be used to protect interior furnishings during peak sun hours or simply to enhance the experience of guests by creating the optimal lighting environment.



*Crestron is a registered trademark of Crestron Electronics, Inc., Rockleigh, NJ
AMX is a registered trademark of AMX, Richardson, TX
Control4 is a registered trademark of Control4 Corporation, Salt Lake City, UT.*

Depending on your project needs, multiple third-party controls are available to integrate motorized window coverings with lighting systems, thermostat controls, and A/V products.



Touch Panel



In Wall Touch Panel



Handheld Remote with LCD Screen

When it comes to delivering convenience and comfort,

MASON MAKES IT AUTOMATIC.

Manual today, MOTORIZED TOMORROW.

With Mason Track III™ you can specify manual hardware today, yet easily have it upgraded to ONE™ motorized drapery systems tomorrow. Our flexibility allows us to help improve the amenities of your property while working within your current project budget and anticipate future upgrade opportunities.

Manual drapery track – Mason Track III™



Motorized drapery track

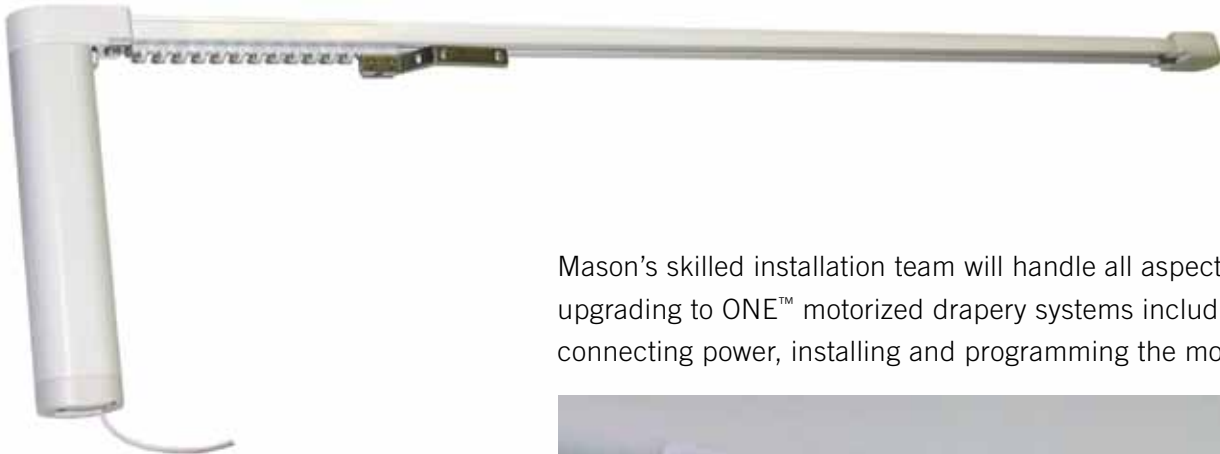





Mason's skilled installation team will handle all aspects of upgrading to ONE™ motorized drapery systems including connecting power, installing and programming the motor.



motorized window treatment specifications

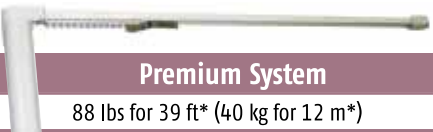

Motor systems feature commercial grade components to ensure long-lasting operation. An overview of the specifications of each ONE™ system may be found below.

Motorized drapery application

		 Standard System	 Premium System
Mechanical	Weight limit for one way	44 lbs for 39 ft* (20 kg for 12 m*)	88 lbs for 39 ft* (40 kg for 12 m*)
	Weight limit for two way	55 lbs for 39 ft* (25 kg for 12 m*)	110 lbs for 39 ft* (50 kg for 12 m*)
	Manual operation	Yes	Yes
	Nominal output shaft torque	5.3 in/lbs (0.6 Nm)	8.8 in/lbs (1 Nm)
	Average Linear Speed (straight track)	8 in/s (20 cm/s)	8 in/s (20 cm/s) with soft start & stop
	Average Noise Level (for information only)	50 Dba SLP	
Electrical	Weight of Motor	1.65 lbs (750 g)	2.43 lbs (1100 g)
	Power Supply (SELV)	24VDC +/- 10% or 24VDC +/- 5%	24VDC +/- 10%
Control and Settings	Nominal Current Consumption	1.1 A	2.7 A
	Control Options	DC switches and other Somfy DC Switching devices. (Polarity switching) 	dry contact switching, infrared (IR)  dry contact switching, infrared (IR), Radio (RTS) 
	Control Line Voltage	24VDC	5VDC SELV (common on ground)
	Control Wiring Connectors (built-in)	N/A	2 x RJ 11 Connectors
	Radio Frequency	433 MHZ	433 MHZ
	Limit Stop	Electronic over-torque detection	
	End Limits Setting	Automatic	
Standards	CE		

*The maximum capacity can vary according to the length and the shape of the rail. Please consult Mason Contract Products.

Motorized roman and roller shade application

		 Standard System	 Premium System
Power supply	DC 24 Vdc	AC (110 v - 60Hz)	
Speed (rpm)	Interior products standard 28 rpm regulated speed 	Interior products standard 32 rpm	
Torque	2 N.m	4 N.m	
Dimensions	Ø1.1in / length 17.7in (Ø31mm / length 450mm)	Ø2in / length 31.5in (Ø50mm / length 800mm)	
Motor Head	White round head for interior blinds	Star head / Round head	
Accessories	compatible with interior blinds, or custom to facilitate integration	compatible with interior blinds, or custom to facilitate integration	
Technology	RTS-WT	WT - IWT - RTS - IR	

MASON CONTRACT PRODUCTS – NEW YORK

85 Denton Avenue

New Hyde Park, NY 11040

(P) 800-233-4454

(F) 516-358-6244

MASON CONTRACT PRODUCTS – LAS VEGAS

3649 East Post Road

Las Vegas, NV 89120

(P) 702-436-3434

(F) 702-436-2323

www.masoncontract.com

Email: info@masoncontract.com

